

28 mm Dome Tweeter

D2905/990000

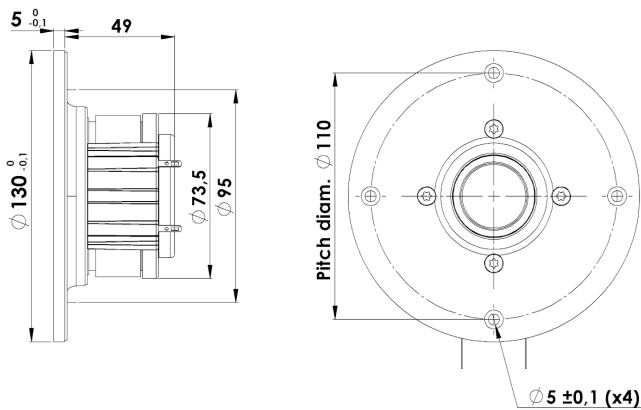

T-S Parameters:

Resonance frequency [fs]	500 Hz
Mechanical Q factor [Qms]	4.83
Electrical Q factor [Qes]	0.72
Total Q factor [Qts]	0.63
Force factor [Bl]	3.5 Tm
Mechanical resistance [Rms]	0.29 kg/s
Moving mass [Mms]	0.45 g
Compliance [Cms]	0.23 mm/N
Effective diaph. diameter [D]	33 mm
Effective piston area [Sd]	8.5 cm ²
Equivalent volume [Vas]	0.02 l
Sensitivity (2,83V/1m)	91 dB

Mechanical Data:

Voice coil diameter	28 mm
Voice coil height	3.3 mm
Voice coil layers	2
Gap height	2.5 mm
Linear excursion	± 0.4 mm
Max mech. excursion	± 1.5 mm
Unit weight	0.8 kg
Cabinet Displacement Volume	0.22 l

Electrical Data:

Nominal impedance [Zn]	6 Ω
Minimum impedance [Zmin]	5.6 Ω
Maximum impedance [Zo]	36.1 Ω
DC resistance [Re]	4.7 Ω
Voice coil inductance [Le]	0.01 mH

Power Handling:

100h RMS noise test (IEC 18.4)	225 W
Long-term max power (IEC 18.2)	430 W
X-over: 2. order HP Butterworth, 2.8 kHz	

Key Features:

- Excellent Sound Reproduction
- 1" Textile Dome Diaphragm
- Patented Symmetrical Drive (SD-2) motor
- Wide Surround Textile Diaphragm
- Large Wave Guide Front
- Black Anodized Mashed Alu Face Plate

Recommendations (please see Tech Note):

- Operating frequency range: 2800-25000 Hz
- Cabinet volume - closed box: N.a.
- Cabinet volume - vented box: N.a.

